



Content

1	Introduction.....	3
1.1	About eSMART.....	3
1.2	Purpose of this document.....	3
2	System components and principal diagrams.....	4
2.1	Materials supplied	4
2.2	eSMART-bridge wiring diagram.....	5
2.3	Technical building diagram of the system	5
2.4	eSMART Gateway	6
2.5	eSMART-plugs and additional features.....	8
3	Details of features	10
3.1	Videophone Intercom.....	10
3.2	Heating regulation, room-by-room.....	12
3.3	Energy consumption monitoring device	14
4	Property management – remote monitoring service	15
	Remote property management interface.....	15
5	Appendix – Comparison of wiring/materials, eSMART-buidling vs. traditional solution	16
5.1	Mounting heights.....	17
5.2	Example of wiring in apartments.....	17

1 INTRODUCTION

1.1 About eSMART

eSMART-building "Touch" combines all the basic functions of the living area on a single interactive touchscreen on the wall or the intercom **"Hello"** or remotely using the eSMART app.

- Video or audio intercom;
- Regulation of the room temperature;
- Control of energy consumption in real time, as well as the graphic display of past data (electricity, heating, hot and cold water);
- Control of lighting, remote-controlled sockets and blinds (optional);
- Alarm detectors for windows and doors, as well as smoke and overflow sensors (optional);

This touch screen also offers functions for modern interactive communication:

- display of energy consumption in relation to normalized thresholds;
- retrieval of information about the local area, local weather, current news or public transport;
- the possibility to write messages (virtual Post-It's) or keep a family calendar;
- the possibility to receive information from the manager or janitor of the building;

The systems of eSMART work on the basis of modern powerline communication technology (PLC). It is thus compatible with all common electrical devices, the choice of which is up to the developer or owner (e.g. switches or sockets). For this reason, no additional wiring, or intervention in the electrical panel is necessary. It is expandable and can be equipped with additional functional extensions of other modules of eSMART or with products of the technology Z-Wave.

The **eSMART-building** system is compliant with the current energy law and allows individual regulation of heating in accordance with energy efficiency and building automation according to SIA 386.110, class B of table 2 (automatic single room regulation by means of thermostatic valves or by electronic regulation devices and presence-dependent control). The product can be extended up to class A with the help of additional sensors. Please contact us if you are interested.

1.2 Purpose of this document

The purpose of this description is to list in detail both the scope of delivery, installation and commissioning, as well as the scope of services of the **eSMART-building** basic system. This basic system offers you the following possibilities:

- **Visitor access** by installing video intercom with bell. Residents can open the main doors via a numeric code lock. The image of the visitor is transmitted to the touch screen and paired smartphone of the residents (craft **electricity**);
- **Regulation of room temperature for each room of the apartment**, manual change of parameterized temperature set points via the touch screen or smartphone (craft **heating** and **electricity**);
- **Display and tracking of consumption** at the different meters (these are not included) for water, hot water, heating and electricity, separately retrievable, both in real time and per desired period (craft **heating, plumbing** and **electricity**);
- **Separate control of the lighting and/or sockets** of each room, without changes to the designated switching systems (craft **electricity**);
- **Remote control of these installations via smartphone** of the residents;

The complete installation allows web-based remote monitoring and offers the following services:

- Query of the recorded data on energy consumption (water, hot water, heating and electricity) per housing unit;
- Communication with the touch screen of the apartment;

2 SYSTEM COMPONENTS AND PRINCIPAL DIAGRAMS

2.1 Materials supplied

The basic version of the eSMART-building system contains the following:

- eSMART-touch (1x)** The wall-mounted touchscreen to be mounted in the entry hall or a central location.
- eSMART-bridge (1x)** Control unit for regulation of valves to the heating system (5 basic zones, expandable) and for meter reading, which is installed either in the electrical panel or in the heating control cabinet. The control units can be installed in a junction box, on a lock plate or exposed. In general, accessibility for maintenance should be provided. Dimensions: 300 mm x 175 mm x 30 mm
- eSMART-temp** Temperature sensors equipped with quick connector cables. Located in each room with temperature regulation.
- eSMART-plugs** Light and socket management modules connected to the temperature sensors to be connected within the cavity wall box of the switch.
- eSMART-video-door** Digital Audio- or Videophone with keypad to be installed in the building entrance.

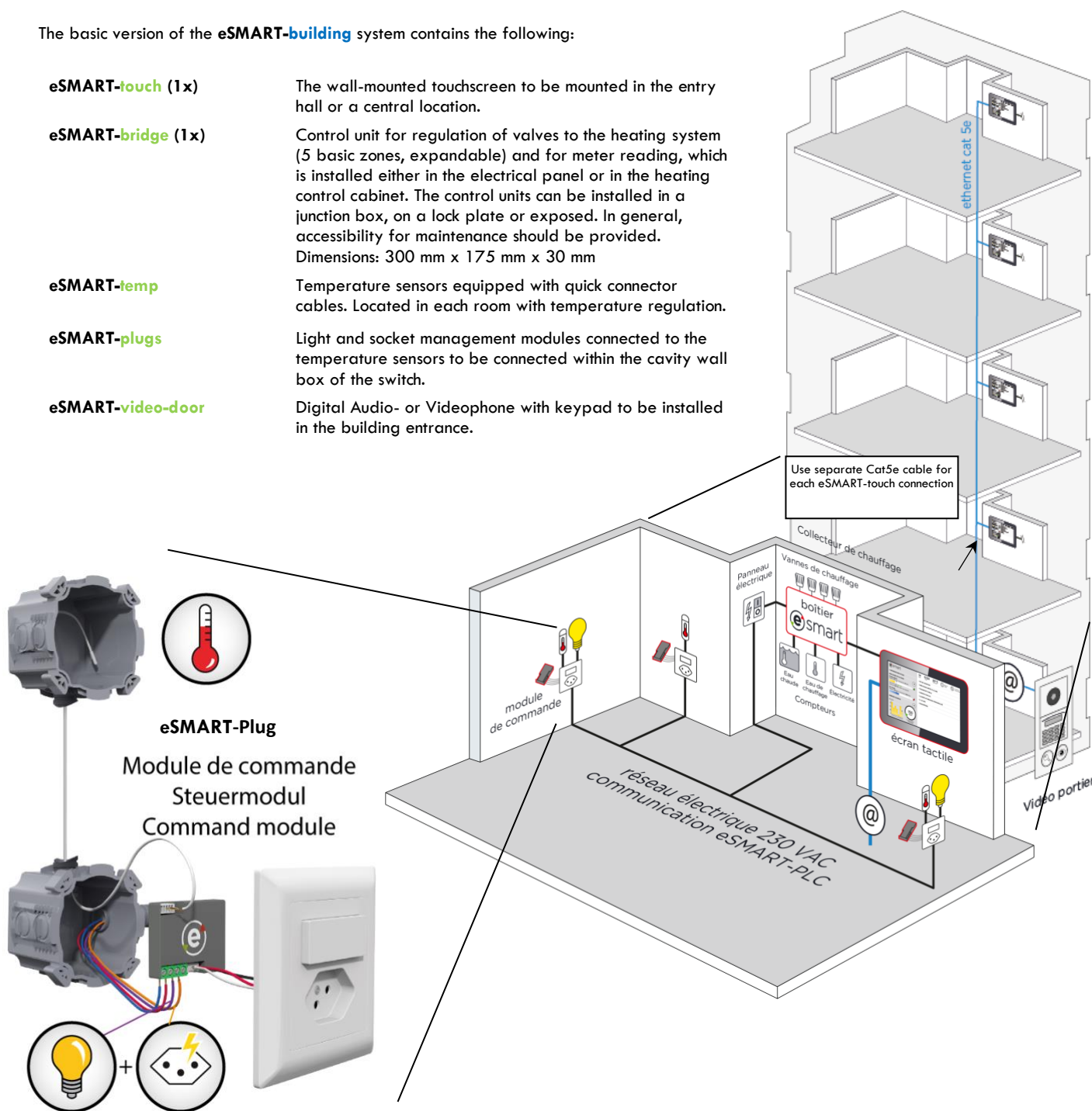

2.2 eSMART-bridge wiring diagram

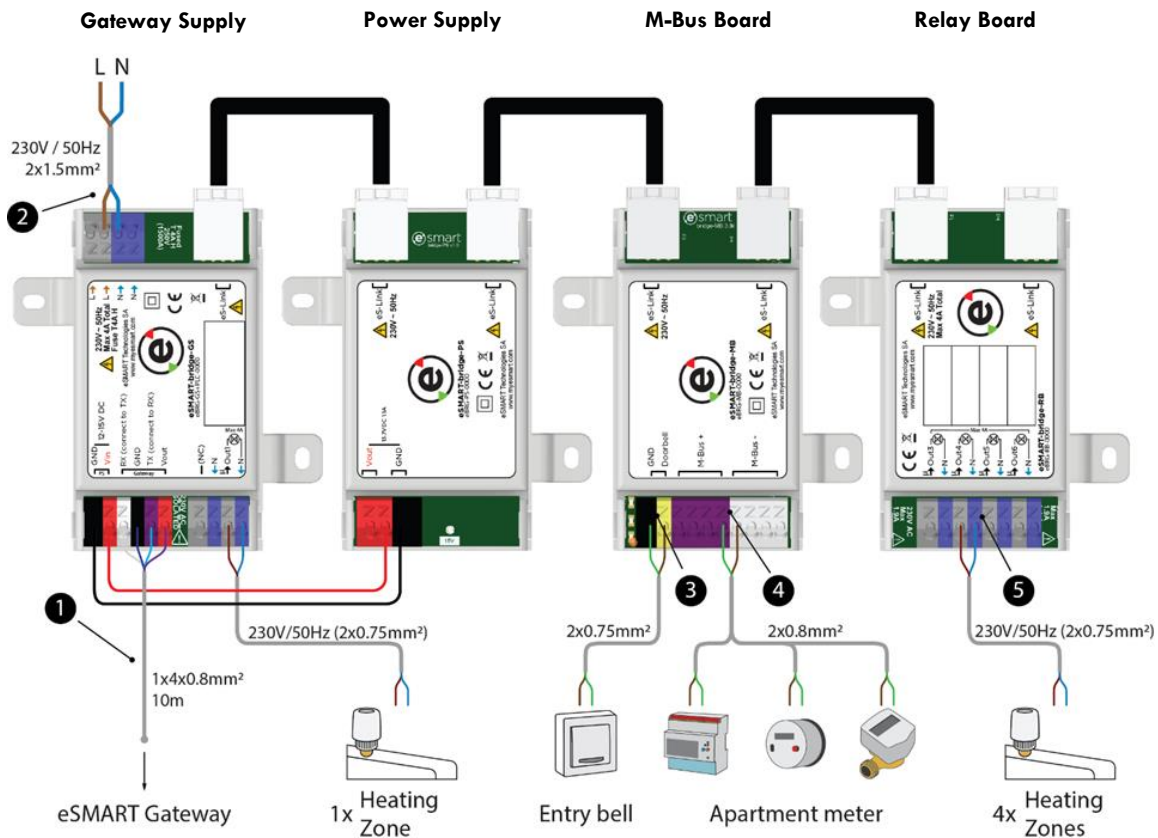

! Recommendation: In case of a self-consumption community install the electricity meter in the basement of the building

- 1 eSMART Gateway <-> eSMART- bridge-GS (Gateway Supply).** 1x4x0.8mm² cable, max. 10m. (>10m 1x4x1.5mm²)
Supply and connection between the eSMART-touch (eSMART-hello or eSMART-connect) and the eSMART-bridge. For distances over 10 m, please contact eSMART.
- 2 eSMART- bridge-PS (Power Supply) <-> Electrical switchboard.** Three-phase 3x1.5 mm² cable
Supply the eSMART bridge and communication via the power supply and the eSMART plugs. Recommendation: run eSMART system on separate phase (e.g. 13A) (redundancy reasons).
- 3 eSMART- bridge-MB (M-Bus Board) <-> Apartment doorbell.** Cable J-Y(St)Y / U72 2x0.8mm² cable. Maximum distance: 25m.
Optionally, the doorbell / door opener in each apartment can be connected to the control unit eSMART-bridge. In this case, a corresponding tube should be planned between the input and the control unit.
- 4 eSMART-bridge-MB (M-Bus Board) <-> M-Bus Meters.** Cable J-Y(St)Y / U72 2x2x0.8mm² Maximum distance: 350m.
Reading M-Bus meters for electricity, heat, cold water, hot water through the system.
Provides the possibility to transfer the ring signal from the entrance area to the screen and to change the ring tone according to individual wishes.
- 5 eSMART-bridge-GS/RB (Relay Board) <-> Heating valves (230V),** Flexible PVC cable 2 x 0.75mm².
Thermoelectric valve control management for floor heating.

Please note: The eSMART-building system requires an internet connection (Recommended: Internet Connexion Download: min. 50Mbit/s; Upload : min. 10Mbit/s.) which **must be provided by the owner of the building**. The number of switch ports will depend on the number of apartments in the building to be connected.

2.3 Technical building diagram of the system

eSMART global wiring design

S20221024/global wiring design/f,d,e

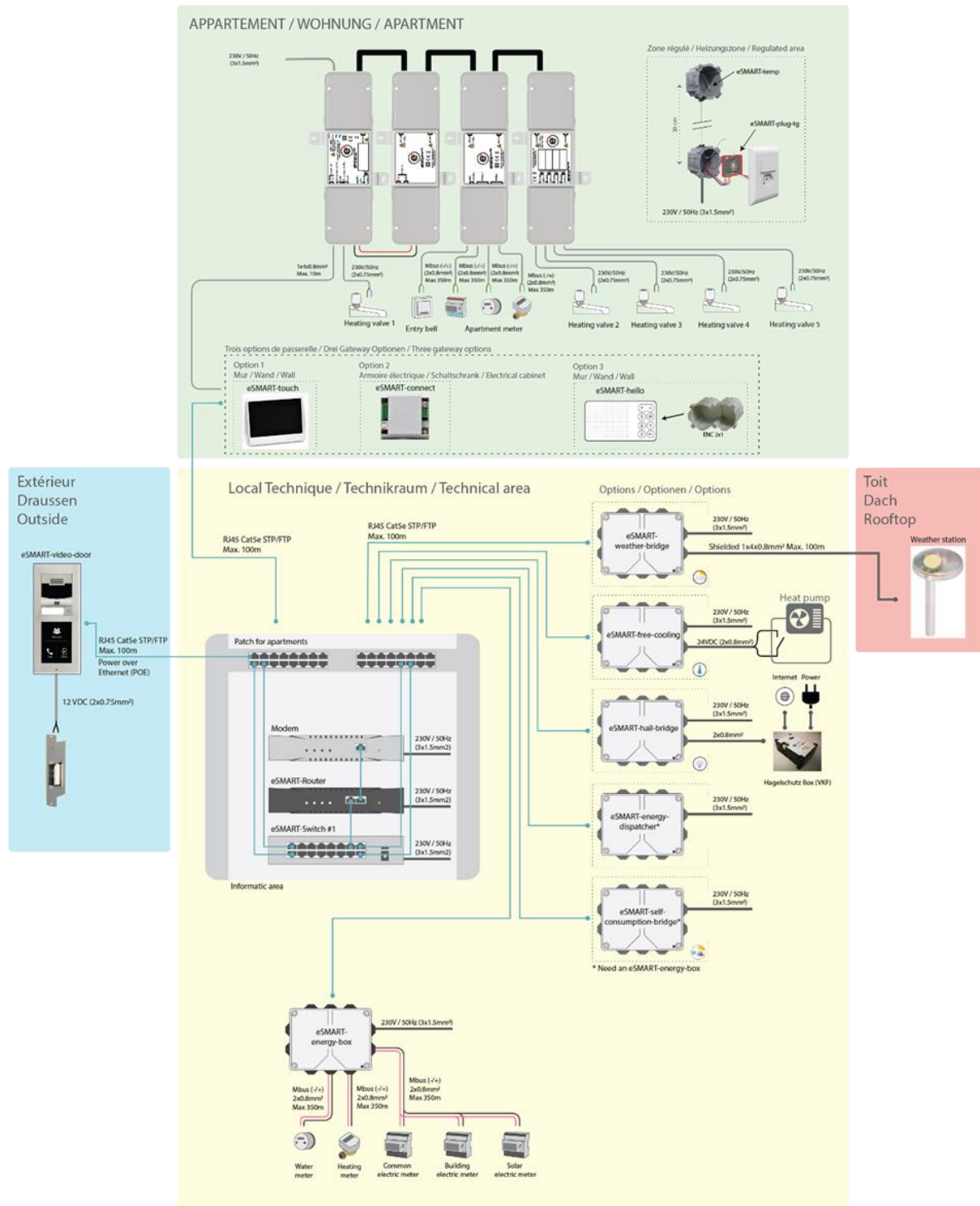

eSMART Technologies SA
 Chemin de la Rueyre 118
 CH-1020 Renens
 Phone: +41 (0)21 552 02 05

2.4 eSMART Gateway

The touch screen monitor **eSMART-touch** (10 inch), the indoor call station **eSMART-hello** or the module **eSMART-connect** serve as the information and control center of the apartment.

Following mounting options are available depending on the Gateway device:

Wall mounted:

Option 1

eSMART-touch

Exposed wall fitting

Screen dimensions: **245 x 197 x 16 mm.**

Option 2

eSMART-hello

Visible mounting on the wall (surface mount)

Device dimension: **175 x 99 x 11 mm**

Recessed mounting box **1x double size ENC 2x1**

HSB Weibel for the connection at the back (horizontal positioning).

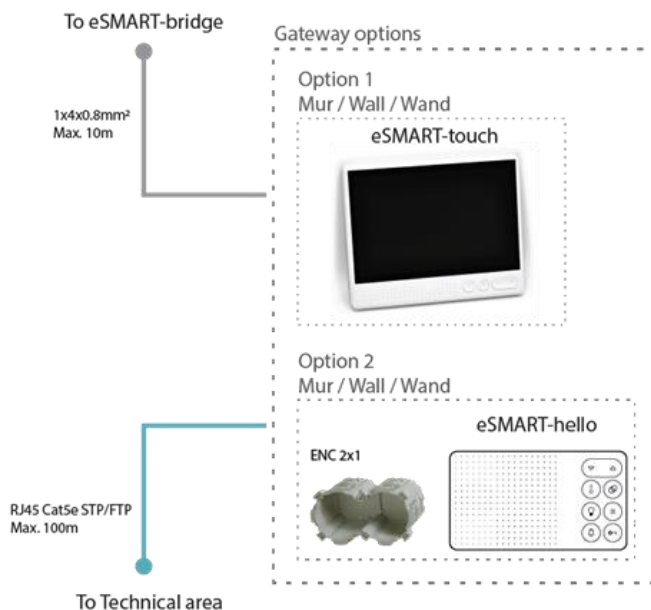

Electrical cabinet

Option 3

The **eSMART-connect** DIN rail module can be directly mounted in the electrical cabinet.



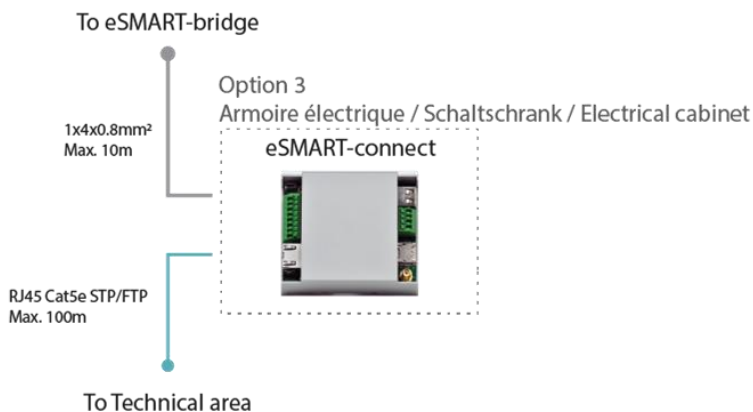









It has a pure gateway functionality for receiving video and audio calls from the doorbell to the doorbell to the smartphone access app.



General: You will need the connections ❶ and ❷ (see diagram on page 5) to install the touchscreen.

2.5 eSMART-plugs and additional features

The **eSMART-building** system is ever evolving and its new features can be integrated easily. Updates can be downloaded without any need to renew or exchange existing modules.

Module type	Imagery	Notes
Additional temperature measurement module eSMART-plug-tg (temperature gateway).		To be connected onto eSMART-plug add-on connector.
Additional heating module eSMART-plug-hh (heat/heat). Maximum 2 x 10A.		If more than 5 heating regulation zones.
Additional double lighting module (rr) eSMART-plug-rr (relay/relay). Maximum 2 x 10A.		1 lamp/socket + 1 lamp/socket.
Additional double lighting module (rd) eSMART-plug-rd (relay/dimmer). Maximum 1 x 10 A (relay) / 1 x 150 W (dimmer).		1 lamp/socket + 1 lamp with varied intensity.
Additional double lighting module (dd) eSMART-plug-dd (dimmer/dimmer). Maximum 2 x 150 W (dimmer).		For 2 lamps with varied intensity.
Blind or shutter module (ud) eSMART-plug-ud (store). Maximum 2 x 10A per up and down channel		For up, down, position and direction.
Additional single lighting module (r) eSMART-plug-r (relay). Maximum 1 x 10A		1 lamp/socket.
Additional single lighting module (d) eSMART-plug-d (dimmer). Maximum 1 x 150 W (dimmer).		For 1 lamp with varied intensity.
Extension lamp driver module eSMART-analog (2 inputs + 2 outputs). 0..10V / 1..10V variations. 		To be connected onto eSMART-plug.
Extension lamp driver module eSMART-dali (2 inputs + 2 outputs). DALI variant. 		To be connected onto eSMART-plug.

 Recommendation: Plan more space for 0/1-10V and DALI expansion modules (deeper / tunnel sockets).

Examples of eSMART-plugs and eSMART-temp wiring

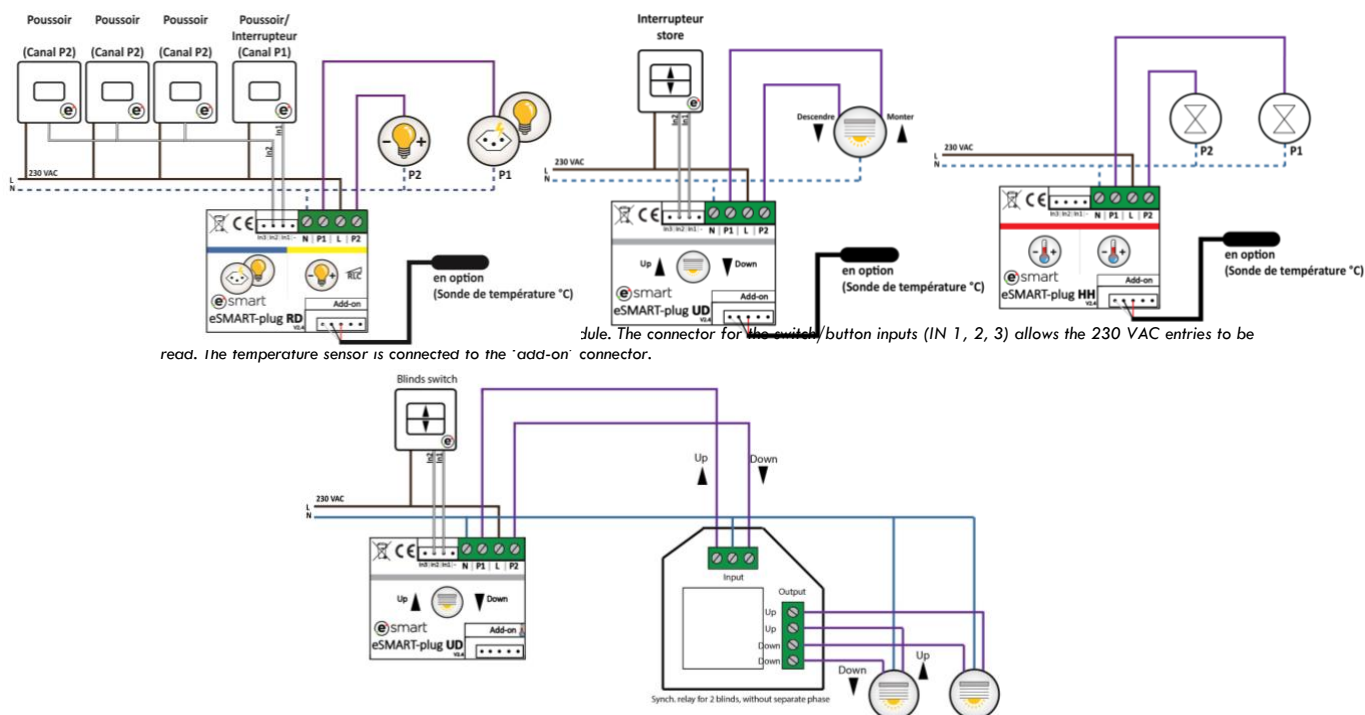

! Use only synchronizing relays for blinds **without separate phase** (see illustration above).
Product reference: AK-TR2/7AEMZ (2 blinds) and AK-T3/9AEMD (3 blinds) or similar.

All data sheets with installation instructions are available for download at <https://myesmart.com/en/downloads/notices-documentations/>

Z-Wave wireless connection

Optionally, radiator valves and state sensors for windows and doors, as well as fire and flooding detection sensors can be connected wireless via Z-Wave to the eSMART PLC network.

Z-Wave is a mesh radio protocol that is designed for home automation that uses low power radio transmissions which utilizes the 868.24 MHz frequency band.

The connection between the eSMART PLC network and the eSMART Z-Wave products is established via the eSMART module eZWA-0001. This module can be connected to each eSMART-plug at the Add-on interface.

Make sure that the antenna module is placed appropriately in order to ensure proper communication. Potential sources of interference and obstacles that affect the radio link must be considered.

The radiator valve eVNC-0002 enables remote heating regulation without changing the whole installation. Furthermore, the Z-Wave compatible door and window contact sensor eZWA-0011 is seamlessly integrable in the eSMART system. Additional smoke eFIR and flood eFLD sensors with alarm server software can be connected via Z-Wave to the eSMART network.

3 DETAILS OF FEATURES

3.1 Videophone Intercom

The video doorbell is equipped with one call button and a touchpad allowing the call to the contact and the opening of the door by a code. The touchpad can be replaced by a numeric keypad or call buttons. A name plate option can also be offered.

Videophone characteristics:

Operating temperature: -40 to +60°C

Protection level: IP54, IK08, touch display IK07

Supported protocol: SIP 2.0

Videophone Module 1



Dimensions for module 1:
107x130x28 mm (WxHxD)

Videophone Modules 2:



Dimensions for module 2:
107x234x28 mm (WxHxD)

Videophone Modules 3:



Dimensions for module 3:
107x339x28 mm (WxHxD)



Cavity dimensions for Module 1:
108x131x45 mm (WxHxD)



Cavity dimensions for Module 2:
108x238x45 mm (WxHxD)



Cavity dimensions for Module 3:
108x343x45 mm (WxHxD)

Technical details (videophones)

The videophone is connected to the technical area of the building via a STP or FTP Cat5e cable and is powered by a Power-over-Ethernet cable. You will need a rack (**19-inch min. 600 x 600 x 9 units high**) for the positioning of switch/router and the risers (RJ45 Cat5). A computer unit is to be installed in the technical area. It contains:

- One or more 100Mbps switches (according to number of apartments/buildings), provided by eSMART;
- One PoE 802.3af power supply provided by eSMART;
- One internet router, to be provided by the building owner, in addition to the internet connection.

The strike plate (not supplied) should work on 12 VDC, it will be connected to videophone in accordance with the manufacturer's recommendations using a 2x0.75mm² cable.

- 1) Powered-Normally Closed (NC) mode: The videophone constantly **powers** the strike plate at 12V DC, when there is a request for the plate to be opened; the videophone cuts the plate's power.
- 2) Powered-Normally Open (NO) mode: when the videophone requires the plate to be opened, it powers **the plate at 12V DC**, the plate is not powered at other times.

3.2 Heating regulation, room-by-room

The **eSMART-building** systems manage each apartment's heating in five distinct zones (extendible via **eSMART-plug-hh** modules) thanks to its temperature sensors which measure the room temperature in each zone in real-time. The control system is included in the **eSMART-bridge** electronic control unit which electronically manages, via 2-point control mode, the standard heating valves (ABN-F-230NC or ABN-F-230NO) provided by the heating engineer.

Technical details (eSMART-plug and eSMART-temp)

A temperature sensor **eSMART-temp** is placed in a flush box and connected to the **eSMART-plug** behind the switch. The cable length of the **eSMART-temp** is 1m, whereas other cable lengths (2m, 5m, 10m, 12m) are upon request.

Supply voltage:	230 V AC/50 Hz.
Connections:	Screw terminal, conductor cross-section max. 1.5mm ² .
Level of protection:	IP20 EN 605029.
Power absorbed:	0.3W.
Permissible room temperature:	-25°C...+45°C.

Provide a connecting tube (distance, reference value 30 cm) vertically above the switch of each regulated room (heating zone) and the flush box of each sensor.

- eSMART recommends the use of cavity wall boxes size 78 x 78 x 58 mm.
Example: AGRO art. no. 9918/E-no. 372 002 929
- Fit the cavity wall box which will house the temperature sensor with a set of perforated liner, e.g. Feller or similar.
Example: Feller EDIZIOduo colore 920-3070.F.61

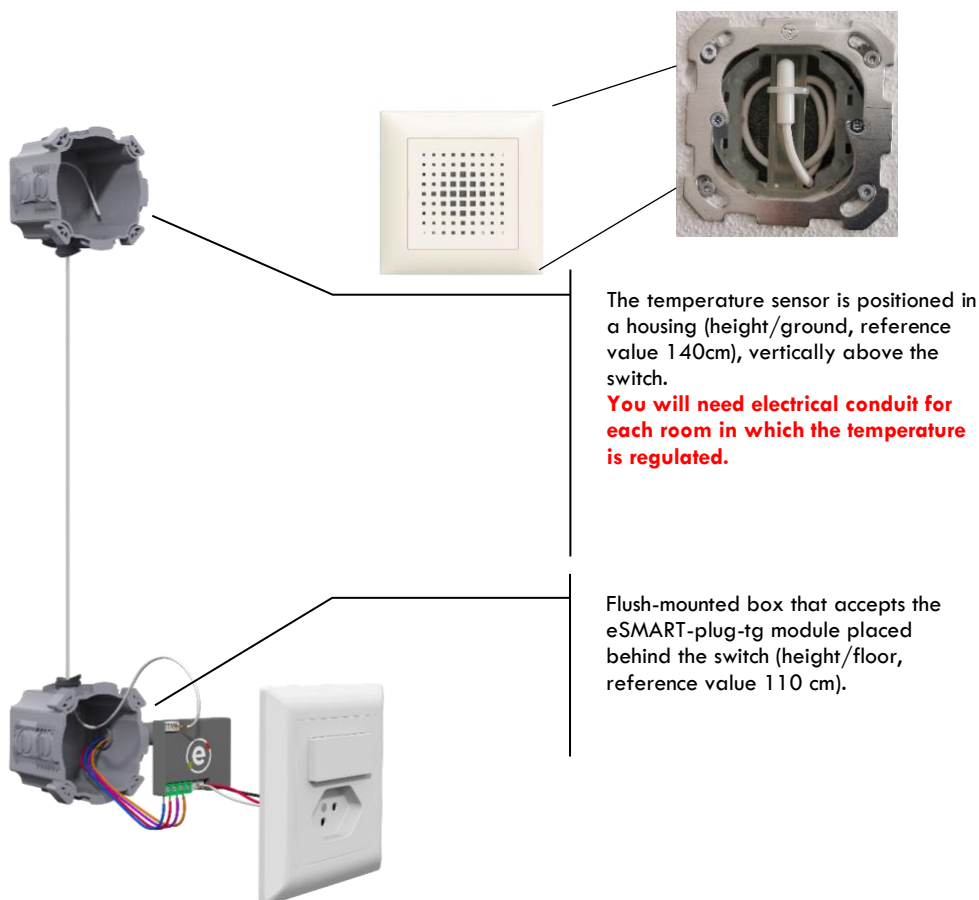

Room thermostat

The eSMART-multi-sensing module eMSS serves to measure temperature, humidity, air pressure and air quality. It has an LED temperature display and capacitive buttons for temperature setting. All measured values are also visible on the eSMART-touch display or the eSMART-app. The Multisense module is connected to the Add-On adapter of an eSMART plug with specially configured firmware.



Weather Station

The weather station measures weather data such as wind strength, brightness, precipitation, temperature, and global radiation (relevant for PV systems). With system extensions, humidity, air pressure and frost can also be determined. Furthermore, hail warnings can be integrated into the system via a hail service API.

The advantage lies in the central configuration and management of all important automatic programs. Examples are:

- Automatic programs for product protection (wind, rain, frost)
- Awnings and blinds raised in case of strong wind
- Shading automation with sun tracking or shadow edge guidance
- Energy utilization function and global radiation evaluation

 For installation details, refer to the technical documentation on the homepage at <https://myesmart.com/en/downloads/notices-documentations/> or consult eSMART



Settings regarding wind resistance class according to SIA standard 342: Class 1,2,3.

The settings must be adjusted depending on the location etc.!

Details on the influence of wind speeds on sun and weather protection systems:

<https://www.neuhaus-storen.ch/skin/downloads/Windgeschwindigkeiten.pdf>

Assignment of wind resistance classes to wind speed (awnings)

Table 2

Class	0	1	2	3
Wind speed ¹⁾	< 7.8 m/s < 28 km/h	7.8 m/s 28 km/h	10.6 m/s 38 km/h	13.3 m/s 48 km/h

¹⁾ Wind speed (gust peaks) measured at the product

3.3 Energy consumption monitoring device

The system provides a global overview of an apartment's energy consumption. The energy meters are read with the help of the **eSMART-bridge** via an integrated M-Bus interface. The basic system can read the following meters via their secondary addresses thanks to compatible M-Bus meters.

Heating 1 Address M-Bus: 2	TECHEM	Compact IV S
	Aquametro	Sensostar U ₂
		Amtron Sonic D ₂
		Amtron S3/S3+ ₂
		Amtron E-30
	Siemens	WFM533
		UH-50
		WSM506, 515, 525
	Kamstrup TECHEM	Multical 602
		Multical 303, 403, 603
Heating 2 Address M-Bus: 8	Landis+Gyr	T230 ₂
		UH-50
	Metrona	XS 2 ₂
	GWF	CF51
		UltraMaXX ₂
	Ista	UltraMaXX ₂
	NeoVac	Supercal 739 Superstatic 749/789
	Zenner	Zelsius C5 Multidata

1 Pulse input not supported

2 Measure every 15 Minutes

Electricity Address M-Bus: 1	EMU	Allrounder 3/75 Professional 3/5 + 3/75 + 3/100
	Hager	ECM381D
	Optec	M3PRO 80 MID + M-BUS 261261
		ECS3-63 CP M-Bus
	NeoVac	7E M-Bus
	Schneider	IEM3135
Hot water 1 Address M-Bus: 3	TECHEM	M-Bus S III Modularis
	Aquametro	Saphir Modularis
Hot water 2 Address M-Bus: 4	GWF	+m ₂
		Unico 2
Cold water 1 Address M-Bus: 5	NeoVac	Modules M-Bus Modularis
		TMP-A ₂
Cold water 2 Address M-Bus: 9	Diehl	Corona E
	Siemens	WFZ31
	Sensus	Residia M
	Wehrle	ETW-EAX

▲ Meters must be installed, addressed and commissioned.

Other types of meter: calculations to be approved in advance with eSMART.

4 PROPERTY MANAGEMENT – REMOTE MONITORING SERVICE

Remote property management interface

The entire system is compatible with a web based remote monitoring service. Property management companies and concierges can access the apartment screens via a secure personal area: <http://webplatform.myesmart.net>.

This service allows you to:

- 1) retrieve and export accurate energy consumption data for each apartment (electricity, hot water, heating);
- 2) take remote meter readings for each apartment: access to electricity data, heating (kWh), cold and hot water (m³) per building and apartment for interim service charge billing;
- 3) export an Excel file detailing annual service charges by period;
- 4) property management companies and concierges can send messages to residents which they will receive directly on their touchscreens;

For any technical questions regarding eSMART specific products, please contact:

eSMART Technologies SA

Support & After Sales Department

Avenue des Baumettes 23

CH-1020 Renens

Phone: +41-21 552 02 04

Mail: support@myesmart.com

Web: www.myesmart.com

5 APPENDIX – COMPARISON OF WIRING/MATERIALS, ESMART-BUILDING VS. TRADITIONAL SOLUTION

Item	Bundle	Location	Quantity
Materials to be removed from the quote			ALSO REQUIRED
1. Standard thermostatic sensors	Electricity	In every room with temperature regulation	x no. rooms with temperature regulation
2. Standard heating regulators	Chauffage	In the heating manifold of each apartment	1 per apartment
3. M-Bus master device	Chauffage	In the building communal areas (often in the basement)	1 per building
4. Videophone / audiophone (street)	Electricity	At the building entrance	1 per building
5. Videophones / audiophones (intern.)	Electricity	At the apartment entrance	1 per apartment
option Visitor chime	Electricity	At the apartment entrance	1 per apartment
Cables/tubes to be removed from the quote			NOT REQUIRED
1. Cables/tubes between the <i>standard thermostatic sensors</i> (a.1) and the <i>heating regulator</i> (b.1)	Electricity	In every room with temperature regulation	x no. rooms with temperature regulation
2. <i>M-Bus riser</i> cables/tubes	Electricity	From the M-Bus master device to all the apartments	1 per building
3. Wiring needed for the audiophone (street and internal) or videophone (street and internal)	Electricity	From the entrance to all the apartments	1 per apartment
Materials to be added to the quote			ALSO REQUIRED
1. Interactive eSMART-touch screen (videophone, energy use measure, heating control zones, etc.)	eSMART	At the apartment entrance	1 per apartment
2. eSMART-box electronic control box standard heating regulator	eSMART	In the heating manifold of each apartment	1 per apartment
3. eSMART-video-door vidéoportier	eSMART	At the building entrance	1 per building
4. eSMART-plug Modules + eSMART-temp temperature sensors	eSMART	In the light switch cavity wall box of each room with temperature regulation	x no. rooms with temperature regulation
5. Rack (60x60cm) for the installation of switch/router	Electricity	In the building communal areas (often in the basement)	1 per building
Cables/tubes to be added to the quote with eSMART			ALSO REQUIRED
1. Tubes between the eSMART-temp temperature sensors verticle to the switches at +30 cm + cavity wall box with perforated cover.	Electricity	In every room with temperature regulation	x no. rooms with temperature regulation
2. Videophone wiring -> Switch/Router and risers in the apartments (RJ45 cat.5)	Electricity	From the building entrance and then to all the apartments	1 entry - communal area + 1 per apartment
3. 1x4x0.8mm tubes/cables between eSMART-box and eSMART-touch	Electricity	Between the entrance hall touchscreen and the heating manifold	1 per apartment
option Tubes/cables 1x2x0.8mm between the hallway call button/bell and eSMART-box	Electricity	Between the entry bell and the heating manifold	1 per apartment

5.1 Mounting heights

Standard mounting:

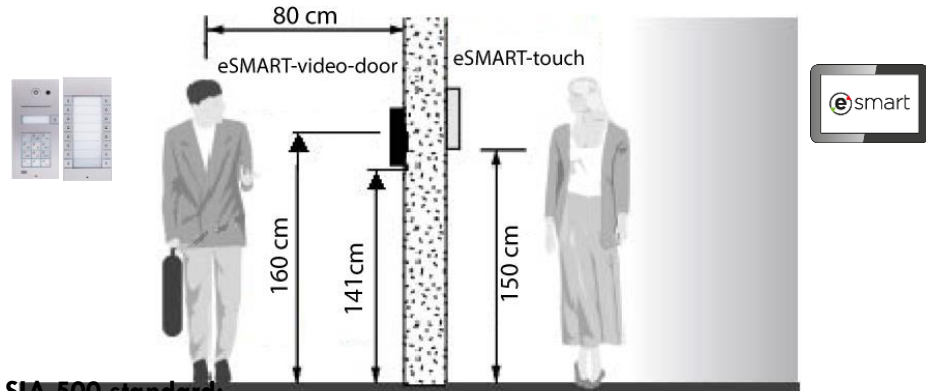

Mounting adapted to the SIA 500 standard:

Variant with video-door above the call buttons:

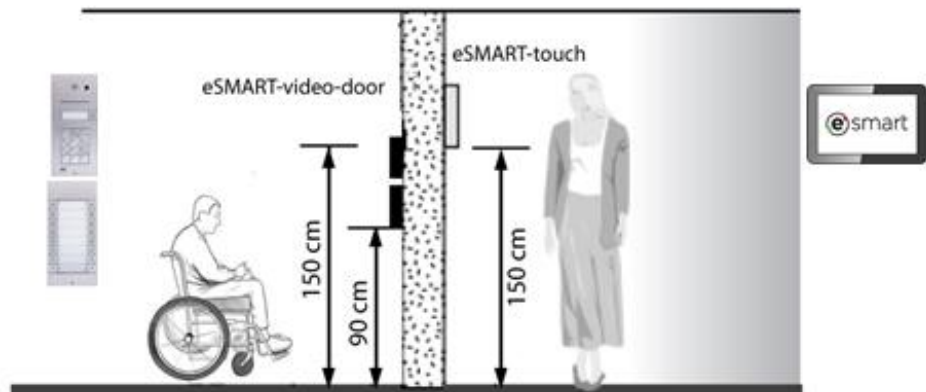

Variant with video-door and call buttons next to each other + ceiling camera*:

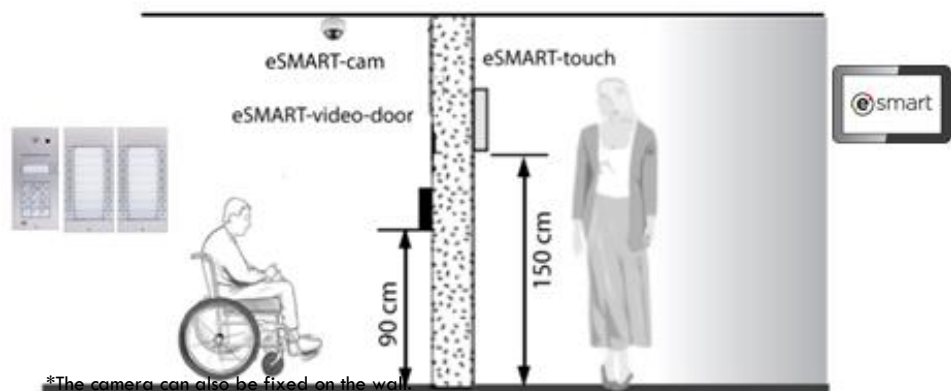

*The camera can also be fixed on the wall.

5.2 Example of wiring in apartments

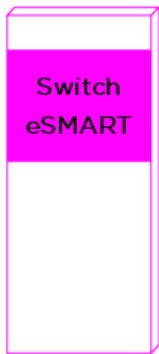
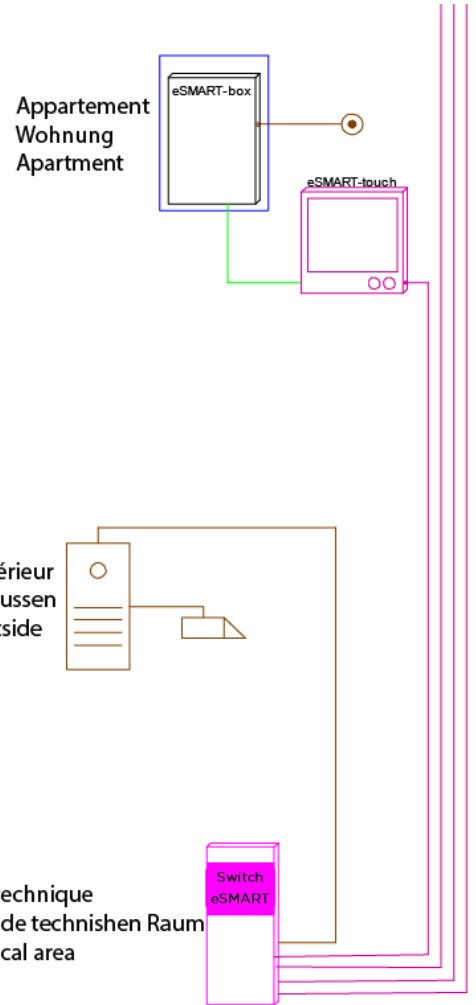
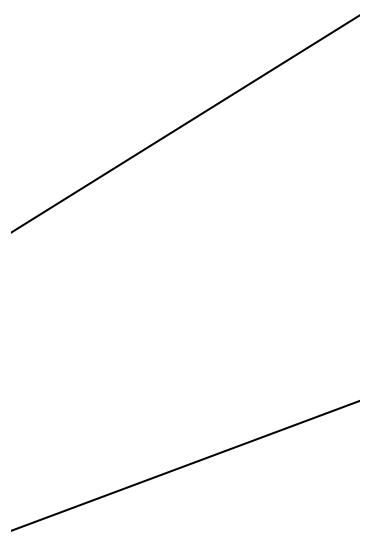
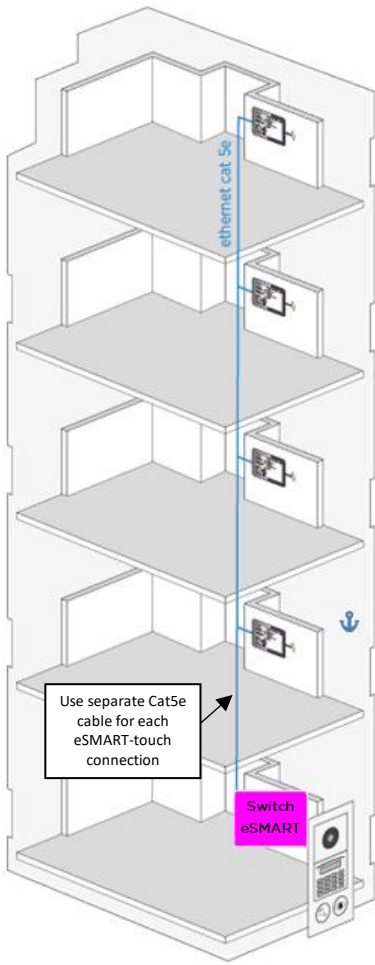

Switch



Vidéo-portier
Türsprechstelle
Video-door



Sonnette
Entry bell
Klingel

